

# BOSTITCH®

## N62FNB

FN15 GA. OIL-FREE ANGLED FINISH NAILER  
CLAVADORA NEUMÁTICA ANGULADA SIN ACEITE CALIBRE FN15  
CLOUEUSE DE FINITION À ANGLE DE CALIBRE FN15 SANS HUILE



**OPERATION and MAINTENANCE MANUAL**  
**MANUAL DE OPERACIÓN Y DE MANTENIMIENTO**  
**MANUEL D'INSTRUCTIONS ET D'ENTRETIEN**

**⚠ WARNING:**

**⚠ ADVERTENCIA:**

**⚠ ATTENTION:**

BEFORE OPERATING THIS TOOL, ALL OPERATORS SHOULD STUDY THIS MANUAL TO UNDERSTAND AND FOLLOW THE SAFETY WARNINGS AND INSTRUCTIONS. KEEP THESE INSTRUCTIONS WITH THE TOOL FOR FUTURE REFERENCE. IF YOU HAVE ANY QUESTIONS, CONTACT YOUR BOSTITCH REPRESENTATIVE OR DISTRIBUTOR.

ANTES DE OPERAR ESTA HERRAMIENTA, TODOS LOS OPERADORES DEBERÁN ESTUDIAR ESTE MANUAL PARA PODER COMPRENDER Y SEGUIR LAS ADVERTENCIAS SOBRE SEGURIDAD Y LAS INSTRUCCIONES. MANTENGA ESTAS INSTRUCCIONES CON LA HERRAMIENTA PARA FUTURA REFERENCIA, SI TIENE ALGUNA DUDA, COMUNÍQUESE CON SU REPRESENTANTE DE BOSTITCH O CON SU DISTRIBUIDOR.

LIRE ATTENTIVEMENT LE PRÉSENT MANUEL AVANT D'UTILISER L'APPAREIL. PRÊTER UNE ATTENTION TOUTE PARTICULIÈRE AUX CONSIGNES DE SÉCURITÉ ET AUX AVERTISSEMENTS. GARDER CE MANUEL AVEC L'OUTIL POUR FUTUR RÉFÉRENCE. SI VOUS AVEZ DES QUESTIONS, CONTACTEZ VOTRE REPRÉSENTANT OU VOTRE CONCESSIONNAIRE BOSTITCH.

**BOSTITCH®**  
STANLEY FASTENING SYSTEMS L.P.

188860RA 07/10

## INTRODUCTION

The Bostitch Ne2FN6 a precision-built tool, designed for high speed, high volume fastening. This tool will deliver efficient, dependable service when used correctly and with care. As with any fine power tool, for best performance the manufacturer's instructions must be followed. Please study this manual before operating the tool and understand the safety warnings and cautions. The instructions on installation, operation and maintenance should be read carefully, and the manuals kept for reference. NOTE: Additional safety measures may be required because of your particular application of the tool. Contact your Bostitch representative or distributor with any questions concerning the tool and its use. Bostitch, Inc., East Greenwich, Rhode Island 02818.

## INDEX

3	Safety Instructions
4	Tool Components
4	Tool Specifications
5	Air Supply & Connections
6	Loading the Tool
7	Trigger Lockout & Selecting Trip Mode
8	Dial-A-Depth™, Integrated Air Blower & 16" O.C. Gauge
9	LED Work-light
10	Integrated Pencil Sharpener & Tool Operation
11	Jam Clearing Procedure
12	Maintaining the Pneumatic Tool
13-14	Trouble Shooting
15	Available Accessories
17	Bostitch Finish & Trim Products

**NOTE:** Bostitch tools have been engineered to provide excellent customer satisfaction and are designed to achieve maximum performance when used with precision Bostitch fasteners engineered to the same exacting standards. Bostitch cannot assume responsibility for product performance if our tools are used with fasteners or accessories not meeting the specific requirements established for genuine Bostitch nails, staples and accessories.



## LIMITED WARRANTY – U.S. and Canada Only

Effective December 1, 2005 Stanley Fastening System L.P. "Bostitch" warrants to the original retail purchaser that the product purchased is free from defects in material and workmanship, and agrees to repair or replace, at Bostitch's option, any defective Bostitch branded pneumatic stapler or nailer for a period of seven (7) years from date of purchase (one (1) year from the date of purchase for compressors and tools used in production applications). Warranty is not transferable. Proof of purchase date required. This warranty covers only damage resulting from defects in material or workmanship; it does not cover conditions or malfunctions resulting from normal wear, neglect, abuse, accident or repairs attempted or made by other than our national repair center or authorized warranty service centers. Driver blades, bumpers, o-rings, pistons and piston rings are considered normally wearing parts. For optimal performance of your Bostitch tool always use genuine Bostitch fasteners and replacement parts.

THIS WARRANTY IS IN LIEU OF ALL OTHER WARRANTIES, EXPRESS OR IMPLIED, INCLUDING BUT NOT LIMITED TO THE IMPLIED WARRANTIES OF MERCHANTABILITY OR FITNESS FOR A PARTICULAR PURPOSE. BOSTITCH SHALL NOT BE LIABLE FOR ANY INCIDENTAL OR CONSEQUENTIAL DAMAGES.

Some states and countries do not allow limitations on how long an implied warranty lasts, or the exclusion or limitation of incidental or consequential damages, so the above limitations or exclusions may not apply to you. This warranty gives you specific legal rights, and you may also have other rights which vary from state to state and country to country.

To obtain warranty service in the U.S., return the product, together with proof of purchase, to the U.S. Bostitch National or Regional Independent Authorized Warranty Service Center. In the U.S., you may call us at 1-800-556-6696 or visit [www.BOSTITCH.com](http://www.BOSTITCH.com) for the location most convenient for you. In Canada please call us at 800-567-7705 or visit [www.BOSTITCH.com](http://www.BOSTITCH.com)

## SAFETY INSTRUCTIONS

**WARNING:** EYE PROTECTION which conforms to ANSI specifications and provides protection against flying particles both from the FRONT and SIDE should ALWAYS be worn by the operator and others in the work area when connecting to air supply, loading, operating or servicing this tool. Eye protection is required to guard against flying fasteners and debris, which could cause severe eye injury.

The employer and/or user must ensure that proper eye protection is worn. Eye protection equipment must conform to the requirements of the American National Standards Institute, ANSI Z87.1 and provide both frontal and side protection. NOTE: Non-side shielded spectacles and face shields alone do not provide adequate protection.

**CAUTION:** Additional Safety Protection will be required in some environments. For example, the working area may include exposure to noise level which can lead to hearing damage. The employer and user must ensure that any necessary hearing protection is provided and used by the operator and others in the work area. Some environments will require the use of head protection equipment. When required, the employer and user must ensure that head protection conforming to ANSI Z89.1 is used.

## AIR SUPPLY AND CONNECTIONS

**WARNING:** Do not use oxygen, combustible gases, or bottled gases as a power source for this tool as tool may explode, possibly causing injury.

**WARNING:** Do not use supply sources which can potentially exceed 200 P.S.I.G. as tool may burst, possibly causing injury.

**WARNING:** The connector on the tool must not hold pressure when air supply is disconnected. If a wrong fitting is used, the tool can remain charged with air after disconnecting and thus will be able to drive a fastener even after the air line is disconnected possibly causing injury.

**WARNING:** Do not pull trigger or depress contact arm while connected to the air supply as the tool may cycle, possibly causing injury.

Always disconnect air supply: 1.) Before making adjustments; 2.) When servicing the tool; 3.) When clearing a jam; 4.) When tool is not in use; 5.) When moving to a different work area, as accidental actuation may occur, possibly causing injury.

## LOADING TOOL

**WARNING:** When loading tool: 1.) Never place a hand or any part of body in fastener discharge area of tool; 2.) Never point tool at anyone; 3.) Do not pull the trigger or depress the trip as accidental actuation may occur, possibly causing injury.

## OPERATION

**WARNING:** Always handle the tool with care: 1.) Never engage in horseplay; 2.) Never pull the trigger unless nose is directed toward the work; 3.) Keep others a safe distance from the tool while tool is in operation as accidental actuation may occur, possibly causing injury.

**WARNING:** The operator must not hold the trigger pulled on contact arm tools except during fastening operation as serious injury could result if the trip accidentally contacted someone or something, causing the tool to cycle.

**WARNING:** Keep hands and body away from the discharge area of the tool. A contact arm tool may bounce from the recoil or driving a fastener and an unwanted second fastener may be driven possibly causing injury.

**WARNING:** Check operation of the contact arm mechanism frequently. Do not use the tool if the arm is not working correctly as accidental driving of a fastener may result. Do not interfere with the proper operation of the contact arm mechanism.

**WARNING:** Do not drive fasteners on top of other fasteners or with the tool at an overly steep angle as this may cause deflection of fasteners which could cause injury.

**WARNING:** Do not drive fasteners close to the edge of the work piece as the wood may split, allowing the fastener to be deflected possibly causing injury.

**WARNING:** This nailer produces SPARKS during operation. NEVER use the nailer near flammable substances, gases or vapors including lacquer, paint, benzine, thinner, gasoline, adhesives, mastics, glues or any other material that is -- or the vapors, fumes or by-products of which are -- flammable, combustible or explosive. Using the nailer in any such environment could cause an EXPLOSION resulting in personal injury or death to user and bystanders.

## MAINTAINING THE TOOL

**WARNING:** When working on air tools note the warnings in this manual and use extra care when evaluating problem tools.

## TOOL COMPONENTS

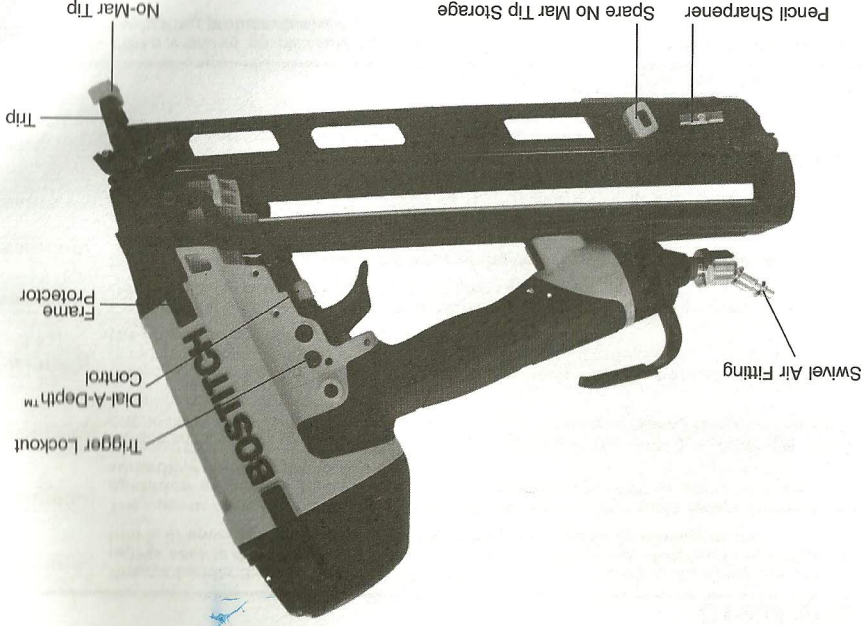
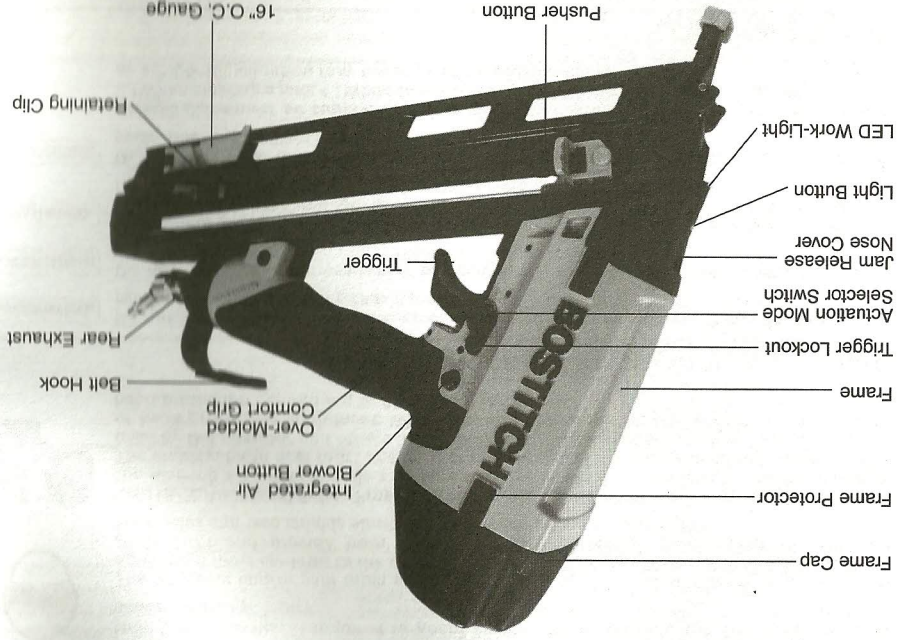

-4-

## TOOL SPECIFICATIONS

<b>Description</b>	FN15ga Angled Finish Nailer
<b>Engine Type</b>	Oil-Free
<b>Operation Pressure Range</b>	70-120 PSI (4.9 to 8.43kg/cm <sup>2</sup> )
<b>Maximum Operation Pressure</b>	120 PSI (8.43 kg/cm <sup>2</sup> )
<b>Fastener Type</b>	FN15 Series
<b>Fastener Gauge</b>	15 Gauge
<b>Fastener Range</b>	1-1/4" - 2-1/2" (31mm - 63mm)
<b>Magazine Capacity</b>	129
<b>Length</b>	14-3/16" (360.3mm)
<b>Width</b>	3-5/8" (92mm)
<b>Height</b>	11-1/16" (296.8mm)
<b>Weight</b>	4.15 lbs. (1.8kg, including fitting)

All dimensions in inches unless otherwise specified.

### Operating Pressure:

70 to 120 p.s.i.g. (4.9 to 8.43 kg/cm<sup>2</sup>). Select the operating pressure within in this range for best fastener performance.

**DO NOT EXCEED THIS RECOMMENDED OPERATING PRESSURE.**

### Air Consumption:

The N62FNB requires 3.9 cubic feet per minute or C.F.M. (110.4 liters per minute or LT/MIN) of free air at 80PSI (5.6 kg/cm<sup>2</sup>) to operate at a rate of 100 fasteners per minute. To determine the appropriately sized air compressor, take the actual rate at which the tool will be run and compare the required C.F.M. (LT/MIN) to the compressors free air delivery (C.F.M./LT/MIN) at 80 PSI (5.6 kg/cm<sup>2</sup>).

For example, if your fastener usage averages 30 fasteners per minute, you need 30% of the tools C.F.M. required to operate the tool at the rate of 100 fasteners per minute. In this case, be sure that your air compressor can deliver a minimum of 1.17 C.F.M. (33.1 LT/MIN) at 80 PSI (5.6 kg/cm<sup>2</sup>) for optimum performance.

## FASTENER SPECIFICATIONS

Tool Model	Fastener Type	Fastener SKU	Gauge	Length
N62FNB	Angled Finish Nails	FN1520	15	1-1/4" (32mm)
		FN1524	15	1-1/2" (38mm)
		FN1528	15	1-3/4" (45mm)
		FN1532	15	2" (50mm)
		FN1536	15	2-1/4" (57mm)
		FN1540	15	2-1/2" (63mm)

\* Stainless steel fasteners also available 1-1/4", 2", and 2-1/2". Visit [www.BOSTITCH.com](http://www.BOSTITCH.com) for further details.

### NOTE:

BOSTITCH tools have been engineered to provide superior customer satisfaction and are designed to achieve maximum performance when used with precision BOSTITCH fasteners engineered to the same exacting standards. BOSTITCH cannot assume responsibility for product performance if our tools are used with fasteners or accessories not meeting the specific requirements established for genuine BOSTITCH fasteners and accessories.

-5-

## AIR SUPPLY AND CONNECTIONS

**WARNING:** Do not use oxygen, combustible gases, or bottled gases as a power source for this tool as tool may explode, possibly causing injury.

### FITTINGS:

Install a male plug on the tool which is free flowing and which will release air pressure from the tool when disconnected from the supply source.

### HOSES:

Air hoses should have a minimum of 150 p.s.i. (10.6 kg/cm<sup>2</sup>) working pressure rating or 150 percent of the maximum pressure that could be produced in the air system. The supply hose should contain a fitting that will provide "quick disconnecting" from the male plug on the tool.

### SUPPLY SOURCE:

Use only clean regulated compressed air as a power source for this tool. NEVER USE OXYGEN, COMBUSTIBLE GASES, OR BOTTLED GASES, AS A POWER SOURCE FOR THIS TOOL AS TOOL MAY EXPLODE.

### REGULATOR:

A pressure regulator with an operating pressure of 0 - 125 p.s.i. (0 - 8.79 kg/cm<sup>2</sup>) is required to control the operating pressure for safe operation of this tool. Do not connect this tool to air pressure which can potentially exceed 200 p.s.i. (14 kg/cm<sup>2</sup>) as tool may fracture or burst, possibly causing injury.

### OPERATING PRESSURE:

Do not exceed recommended maximum operating pressure as tool wear will be greatly increased. The air supply must be capable of maintaining the operating pressure at the tool. Pressure drops in the air supply can reduce the tool's driving power. Refer to "TOOL SPECIFICATIONS" for setting the correct operating pressure for the tool.

### FILTER:

Dirt and water in the air supply are major causes of wear in pneumatic tools. A filter will help to get the best performance and minimum wear from the tool. The filter must have adequate flow capacity for the specific installation. The filter has to be kept clean to be effective in providing clean compressed air to the tool. Consult the manufacturer's instructions on proper maintenance of your filter. A dirty and clogged filter will cause a pressure drop which will reduce the tool's performance.



## LOADING THE N62FNB

**WARNING:** EYE PROTECTION which conforms to ANSI specifications and provides protection against flying particles both from the FRONT and SIDE should ALWAYS be worn by the operator and others in the work area when connecting to air supply, loading, operating or servicing this tool. Eye protection is required to guard against flying fasteners and debris, which could cause severe eye injury.



The employer and/or user must ensure that proper eye protection is worn. Eye protection equipment must conform to the requirements of the American National Standards Institute, ANSI Z87.1 and provide both frontal and side protection. NOTE: Non-side shielded spectacles and face shields alone do not provide adequate protection.

### WARNING: TO PREVENT ACCIDENTAL INJURIES:

- Never place a hand or any other part of the body in nail discharge area of tool while the air supply is connected.
- Never point the tool at anyone else.
- Never engage in horseplay.
- Never pull the trigger unless nose is directed at the work.
- Always handle the tool with care.
- Do not pull the trigger or depress the trip mechanism while loading the tool.

## LOADING THE N62FNB

The N62FNB nailers are equipped with dual load purpose magazines. Nails can be loaded in either method.

### LOAD AND PULL PUSHER

1. Load nails through the slot in the rear of the magazine to past retaining clip.
2. Pull pusher back behind nail stick and release.
3. Ensure magazine pusher is behind the last nail stick.
4. Blow the magazine clean periodically to keep the pusher moving smoothly and to keep dirt and debris out of the nail channel.

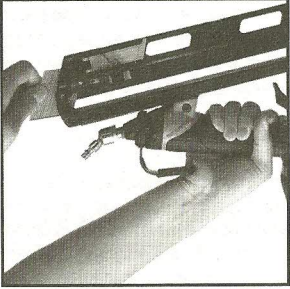

### PULL PUSHER TO LOCK BACK AND LOAD

1. Pull pusher back until it is locked at the end of magazine.
2. Load nails through the slot in the rear of the magazine and past retaining clip.
3. Press the pusher button to release and allow the pusher to push behind the nails.
4. Blow the magazine clean periodically to keep the pusher moving smoothly and to keep dirt and debris out of the nail channel.

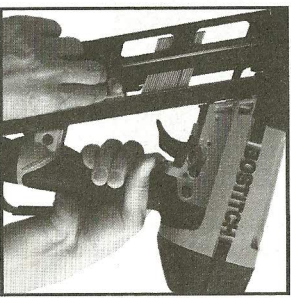

## TRIGGER LOCKOUT CONTROL

The trigger lockout control feature on BOSTTICH pneumatic tools provides a trigger lock feature for added safety control. Push the lockout control button in or out to activate or lock the tool trigger.

Trigger Lockout Control Button

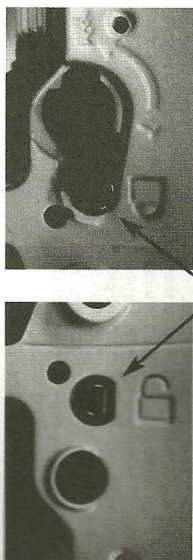

## TRIP OPERATION MODE

**WARNING:** Always disconnect air supply before making adjustments as accidental actuation may occur, possibly causing injury.

**WARNING:** Always verify and be aware of tool operating mode by inspecting the trigger before connecting to an air supply and / or using the tool.

The N62FNB features a selectable trigger system that allows the user to choose between the following modes of operation:

1. Contact Trip Operation
2. Sequential Trip Operation

### 1. CONTACT TRIP:

**WARNING:** NEVER use the belt hook with the tool in contact mode, ALWAYS switch the tools operation mode back to sequential before using the belt hook option.

The common operation procedure on "Contact Trip" tools is for the operator to contact the work surface to actuate the trip mechanism while keeping the trigger pulled, thus driving a fastener each time the work surface is contacted. This will allow rapid fastener placement on many jobs. All pneumatic tools are subject to recoil when driving fasteners. The tool may bounce, releasing the trip, and if unintentionally allowed to re-contact the work surface with the trigger still actuated (finger still holding the trigger pulled) an unwanted second fastener will be driven.

### 2. SEQUENTIAL TRIP:

The Sequential Trip requires the operator to hold the tool against the work before pulling the trigger. This makes accurate fastener placement easier. The Sequential Trip allows exact fastener location without the possibility of driving a second fastener on recoil as described under "Contact Trip". The Sequential Trip Tool has a positive advantage because it will not accidentally drive a fastener if the tool is contacted against the work surface - or anything else - while the operator is holding the trigger pulled.

## SELECTING THE TRIP MODE:

To ensure safety, the user must lock the trigger (as described above) before changing the trigger system. To change the trip mode, rotate the mode switch in the counterclockwise direction. The mode switch will lock automatically when the indicating arrow is pointing down to the 3 nail icon stamped into the tool frame (Contact Trip Mode) or to a single nail icon stamped in the tool frame (Sequential Trip Mode). Unlock the trigger to resume tool operation.

Contact Trip Mode

(trip mode selector switch pointing down)

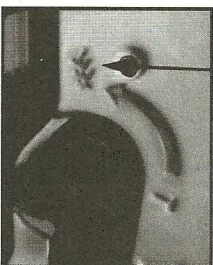

Sequential Trip Mode

(trip mode selector switch pointing up)

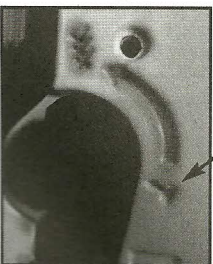

## DIAL-A-DEPTH™ FASTENER CONTROL ADJUSTMENT

The DIAL-A-DEPTH™ Fastener control adjustment feature provides close control of the fastener drive depth: from flush with the work surface to shallow or deep countersink.

First set the air pressure for consistent drive in the specific work as described on page 5, then use the DIAL-A-DEPTH™ fastener control adjustment to give the desired depth of drive.

Dial-A-Depth™ Fastener Control Adjustment

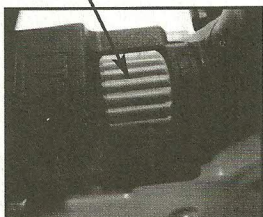

## IN ADDITION TO THE OTHER WARNINGS CONTAINED IN THIS MANUAL OBSERVE THE FOLLOWING FOR SAFE OPERATION

- Use the BOSTTICH pneumatic tool only for the purpose for which it was designed.
- Never use this tool in a manner that could cause a fastener to be directed toward the user or others in the work area.
- Do not use the tool as a hammer.
- Always carry the tool by the handle. Never carry the tool by the air hose.
- Do not alter or modify this tool from the original design or function without approval from BOSTTICH, INC.
- Always be aware that misuse and improper handling of this tool can cause injury to yourself and others.
- Never clamp or tape the trigger or contact trip in an actuated position.
- Never leave a tool unattended with the air hose attached.
- Do not operate this tool if it does not contain a legible WARNING LABEL.
- Do not continue to use a tool that leaks air or does not function properly. Notify your nearest Bostitch representative if your tool continues to experience functional problems.

## INTEGRATED AIR BLOWER

**WARNING:** NEVER blow debris toward yourself to others in the work area.

N62FNB has a integrated air blower that helps clean debris while working. Press the integrated air blower button. Compressed air will be ejected out from front of the tool. Released the button to stop blowing air.

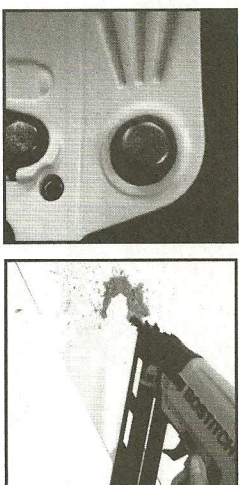

## 16" O.C. GAUGE

16" O.C. gauge helps to indicate stud location.

1. Pull up the O.C. gauge to rotate to the opposite side.
2. Press on the O.C. gauge to snap into the magazine.
3. 16" is measured from nose to the tip of O.C. gauge to help find stud.

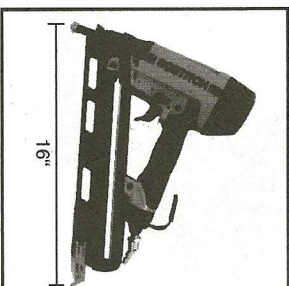
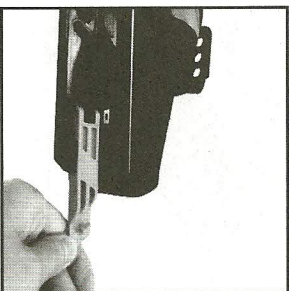
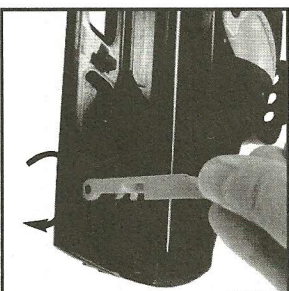

## LED WORK-LIGHT

To operate the LED work-light you must first remove an electrically isolated plastic sheet before using the LED

work-light.

1. Pull up the nose cover to open.

2. Pull out the electrically isolated plastic sheet.

3. Close the nose cover.

4. LED light is on/off by pressing light button on the cover.

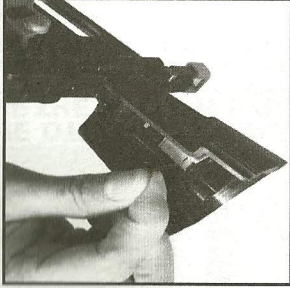

## REMOVE THE LIGHT

LED work-light can be easily removed or if needed.

1. Pull up the nose cover to open

2. Press on the snap-fitting hook to release LED work-light.

3. Take out the LED work-light from the cover.

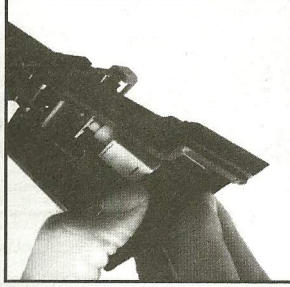
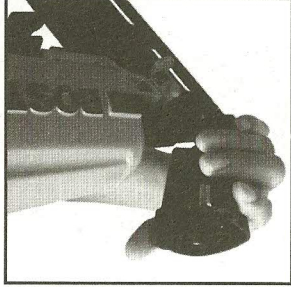

## REPLACE THE LIGHT (Kit number: N62-LED)

Insert a new LED work-light.

1. Align housing of the LED work-light into nose cover until it snaps into position. Make sure the button is placed

through nose cover hole.

2. Pull out the electrically isolated plastic sheet.

3. Close the nose cover.

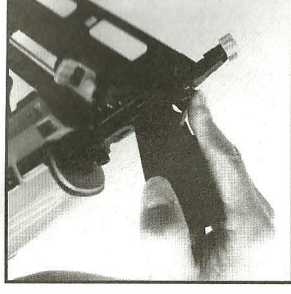
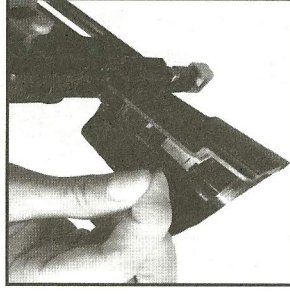
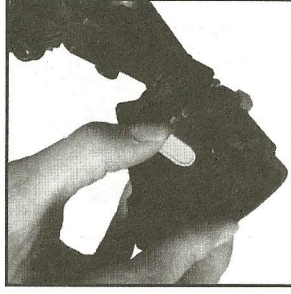

## USING THE INTEGRATED PENCIL SHARPENER

A standard pencil sharpener is integrated into the magazine for the operator's convenience. To sharpen a pencil, insert any standard pencil into the hole and rotate the pencil to the right (clockwise) to sharpen.

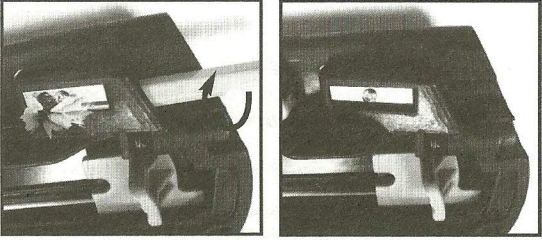

## TOOL OPERATION

**EYE PROTECTION** which conforms to ANSI specifications and provides protection against flying particles both from the **FRONT** and **SIDE** should **ALWAYS** be worn by the operator and others in the work area when connecting to air supply, loading, operating or servicing this tool. Eye protection is required to guard against flying fasteners and debris, which could cause severe eye injury.



### WARNING:

The employer and/or user must ensure that proper eye protection is worn. Eye protection equipment must conform to the requirements of the American National Standards Institute, ANSI Z87.1 and provide both frontal and side protection. NOTE: Non-side shielded spectacles and face shields alone do not provide adequate protection.

## BEFORE HANDLING OR OPERATING THIS TOOL:

I. READ AND UNDERSTAND THE WARNINGS CONTAINED IN THIS MANUAL.

II. REFER TO "TOOL SPECIFICATIONS" IN THIS MANUAL TO IDENTIFY THE OPERATING SYSTEM ON YOUR TOOL.

## OPERATION

### 1. CONTACT TRIP OPERATION:

**WARNING:** NEVER use the belt hook with the tool in contact mode, ALWAYS switch the tools operation mode back to sequential before using the belt hook option.

In CONTACT TRIP MODE the tool contains a contact trip that operates in conjunction with the trigger to drive a fastener. There are two methods of operation to drive fasteners with a contact trip tool.

A. SINGLE FASTENER PLACEMENT: To operate the tool in this manner, first position the contact trip

on the work surface, WITHOUT PULLING THE TRIGGER. Depress the contact trip until the nose touches the work surface and then pull the trigger to drive a fastener. Do not press the tool against the work with extra force. Instead, allow the tool to recoil off the work surface to avoid a second

unwanted fastener. Remove your finger from the trigger after each operation.

B. RAPID FASTENER OPERATION: To operate the tool in this manner, hold the tool with the contact trip pointing towards but not touching the work surface. Pull the trigger and then tap the contact trip against the work surface using a bouncing motion. Each depression of the contact trip will cause a fastener to be driven.

The operator must not hold the trigger pulled on contact trip tools except during fastening operation, as serious injury could result if the trip accidentally contacted someone or something, causing the tool to cycle.

Keep hands and body away from the discharge area of the tool. A contact trip tool may be bounce from the recoil of driving a fastener and an unwanted second fastener may be driven, possibly causing injury.

### 2. SEQUENTIAL TRIP OPERATION:

In SEQUENTIAL TRIP MODE the contact trip operates in conjunction with the trigger to drive a fastener. THE TRIGGER. Depress the contact trip and then pull the trigger to drive a fastener. As long as the contact trip is contacting the work and is held depressed, the tool will drive a fastener each time the trigger is depressed. If the contact trip is allowed to leave the work surface, the sequence described above must be repeated to drive another fastener.

## JAM CLEARING PROCEDURE

**WARNING:** Disconnect tool from air supply before making adjustments or before attempting any part assembly or disassembly.

On occasion nails can jam in the nose of a pneumatic nailer. This can be caused by striking a metal plate in the wall, drywall screw, or some other hard object. The N62FNB feature can open drive channel architecture for jam clearing. To clear a jam follow this procedure:

1. Disconnect the tool from the air supply.
2. Release the pusher so it is no longer applying force to the nail sticks.
3. Open the jam clearing nose door by pulling down and then up on the latch.
4. Remove the jammed fastener. In certain circumstances, pliers may be required to remove the fastener.
5. Close the jam clearing nose door latch.
6. Pull nail pusher back behind nail sticks.

### N62FNB JAM CLEARING

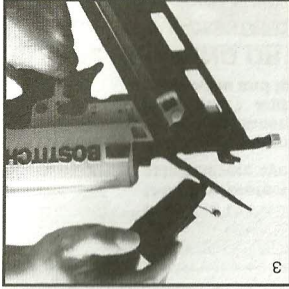
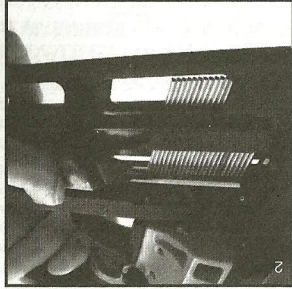
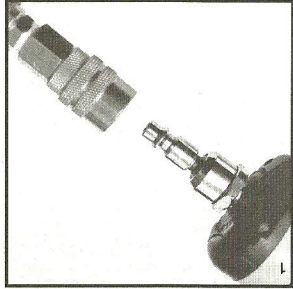
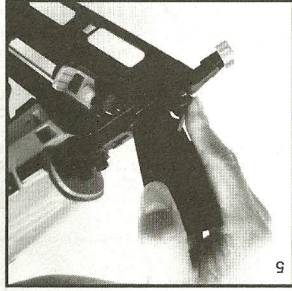
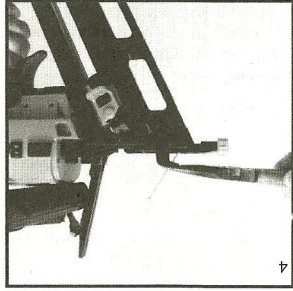
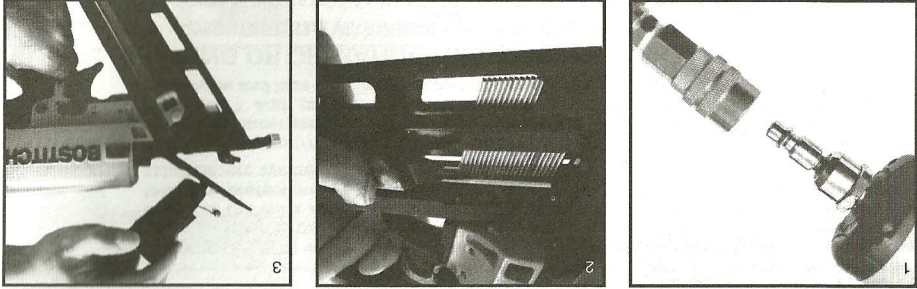

## TOOL OPERATION CHECK

**CAUTION:** Remove all fasteners from tool before performing tool operation check.

### 1. CONTACT TRIP OPERATION:

A. With finger off the trigger, press the contact trip against the work surface. **THE TOOL MUST NOT CYCLE.**

B. Hold the tool off the work surface, and pull the trigger. **THE TOOL MUST NOT CYCLE.**

C. With the tool off the work surface, pull the trigger. Press the contact trip against the work surface. **THE TOOL MUST CYCLE.**

D. Without touching the trigger, press the contact trip against the work surface, then pull the trigger. **THE TOOL MUST CYCLE.**

### 2. SEQUENTIAL TRIP OPERATION:

A. Press the contact trip against the work surface, without touching the trigger. **THE TOOL MUST NOT CYCLE.**

B. Hold the tool off the work surface and pull the trigger. **THE TOOL MUST NOT CYCLE.**

C. Pull the trigger and press the contact trip against the work surface. Release the trigger. The trigger must return to the trigger stop on the frame. **THE TOOL MUST NOT CYCLE.**

D. With finger off the trigger, press the contact trip against the work surface. Pull the trigger. **THE TOOL MUST CYCLE.**

## MAINTAINING THE PNEUMATIC TOOL

**WARNING:** When working on air tools, note the warnings in this manual and use extra care evaluating problem tools.

**CAUTION:** Pusher spring (constant force spring). Caution must be used when working with the spring assembly. The spring is wrapped around, but not attached to, a roller. If the spring is extended beyond its length, the end will come off the roller and the spring will roll up with a snap, with a chance of pinching your hand. Also the edges of the spring are very thin and could cut. Care must also be taken to insure no permanent kinks are put in the spring as this will reduce the springs force.

### REPLACEMENT PARTS:

Use only genuine BOSTITCH replacement parts. Do not use modified parts.

### ASSEMBLY PROCEDURE FOR SEALS:

When repairing a tool, make sure the internal parts are clean and lubricated. Use Parker "O"-LUBE, Magnalube, or equivalent on all "O"-rings. Coat each "O"-ring with lubricant before assembling.

### AIR SUPPLY-PRESSURE AND VOLUME:

Air volume is as important as air pressure. The air volume supplied to the tool may be inadequate because of undersize fittings and hoses, or from the effects of dirt and water in the system. Restricted air flow will prevent the tool from receiving an adequate volume of air, even though the pressure reading is high. The results will be slow operation, misfeeds or reduced driving power. Before evaluating tool problems for these symptoms, trace the air supply from the tool to the supply source for restrictive connectors, low points containing water and anything else that would prevent full volume flow of air to the tool.

# MAINTENANCE CHECKLIST

Maintenance	Benefit	Procedure	Service Interval
Inspect trigger performance	Ensure trigger system is in proper working order	Refer to Tool Operation Check section in this manual	Daily
Drain condensation from air compressor tanks and air filters (if present)	Prevents accumulation of moisture that can impede tool performance	Open drain cock on tanks and air filters and drain all condensate	Daily
Clean magazine assembly	Prevents accumulation of debris that could cause a jam	Blow clean with compressed air	Daily
Clean nose assembly	Prevents accumulation of debris that could cause a jam	Blow clean with compressed air	Daily
Ensure all fasteners remain tight	Prevent loose parts	Tighten all fasteners with appropriately sized hex wrench	Weekly
Check/clean air inlet air filter	Maintains proper air flow to engine for peak performance.	Remove end cap and use compressed air blow gun to blow filter clean. Replace filter if used in dusty location	25,000 Fasteners, or monthly
Replace no-mar tip	Prevents marks in softwood applications	Remove worn no-mar tip and replace with a new tip (a spare tip is located on the magazine)	25,000 Fasteners
Replace swivel air fitting	Maintains proper air flow to engine for peak performance	Remove worn swivel air fitting and replace with new swivel fitting	50,000 Fasteners
Replace piston/driver assembly	Maintains consistent drive quality	Refer to replacement part kit instructions	250,000 Fasteners
Replace O-rings	Maintains engine for peak performance	Refer to replacement part kit instructions	250,000 Fasteners
Replace bumper	Maintains engine for peak performance	Refer to replacement part kit instructions	250,000 Fasteners
Replace headvalve	Maintains engine for peak performance	Refer to replacement part kit instructions	250,000 Fasteners
Replace engine cylinder	Maintains engine for peak performance	Refer to replacement part kit instructions	500,000 Fasteners

## PROBLEM

## CAUSE

## CORRECTION

Trigger valve housing leaks air	O-ring cut or cracked	Replace O-ring
Trigger valve stem leaks air	O-ring or gasket is cut or cracked	Replace O-ring or gasket
Frame/nose leaks air	Bumper cracked/worn	Replace bumper
Damaged gasket or seal	Replace gasket or seal	
Cracked/worn head valve	Replace head valve	
Loose cap screws	Tighten and recheck	
Air supply restriction	Check air supply equipment	Replace head valve
Worn head valve	Replace head valve	
Broken cylinder cap spring	Replace cylinder cap spring	
Head valve stuck in cap	Disassemble / Check / Lubricate	
Broken cylinder cap spring	Replace cap spring	
Rings/seals cut or cracked	Replace rings/seals	
Exhaust blocked	Check bumper, head valve spring	
Trigger assembly worn/leaks	Replace trigger assembly	
Dirt/tar build up on driver	Disassemble nose/driver to clean	
Cylinder sleeve not seated correctly	Disassemble to correct	
on bottom bumper	Disassemble to correct	
Air pressure too low	Check air supply equipment	
Clogged air filter	Clean or replace air filter	
Intermittent feed	Worn bumper	Replace bumper
	Tar/dirt in driver channel	Disassemble and clean nose and driver
	Air restriction/inadequate air flow through quick disconnect socket and plug	Replace quick disconnect fittings
	Worn piston ring	Replace ring, check driver
	Damaged pusher spring	Replace spring
	Low air pressure	Check air supply system to tool
	Loose magazine nose screws	Tighten all screws
	Fasteners too short for tool	Use only recommended fasteners
	Bent fasteners	Discard and use correct fasteners
	Wrong size fasteners	Use only recommended fasteners
	Leaking head cap gasket	Tighten screws/replace gasket
	Trigger valve O-ring cut/worn	Replace O-ring
	Broken/chipped driver	Replace driver (check piston ring)
	Dry/dirty magazine	Clean/lubricate use BOSTITCH Air Tool Lubricant
	Worn magazine	Replace magazine
	Clogged air filter	Clean or replace air filter
Fasteners jam in tool	Driver channel worn	Replace nose/check door
	Wrong size fasteners	Use only recommended fasteners
	Bent fasteners	Discard and use correct fasteners
	Loose magazine/nose screws	Tighten all screws
	Broken/chipped driver	Replace driver

# TROUBLE SHOOTING